

## iCON™ Residential Meter

With an unsurpassed accuracy exceeding ANSI C12.20 (Class 0.2), the iCon Meter by Sensus Metering Systems is built with a backbone of reliability and precision. Developed with flexibility in mind, the iCon meter is compatible with multiple AMR solutions, even technologies that may exist in the future. The open architecture and two-board design allow for this compatibility, allowing simple and cost effective integration with communication technologies.

### Meter Types

- **iS01** Residential meter
- **iSA1** Residential meter with AMR
- **iNO1** Network meter
- **iNA1** Network meter with AMR

### Advanced Sentec\* Sensor Technology

- Designed for billing accuracy
- Reliable, one piece construction
- Complete DC Immunity

\*Includes technology licensed from Sentec, Ltd.



### Features of iCon™ Meter

- Accuracy exceeds ANSI C12.20 (Class 0.2)
- kWh energy measurement, net metering, voltage monitoring
- Disassembles and upgrades easily without tools
- Inversion proof
- Two-board, cost competitive design
- Cost competitive AMR integration
- Open architecture for seamless AMR integration and upgrades
- ANSI compliance in performance and design

### AMR Compatibility

- Sensus FlexNet with AMDS Connect
- Sensus RadioRead
- Cannon MCT-410
- Hunt TS2
- Hexagram Star MTU
- Invensys Goodwatts Energy
- Itron 51ESS ERT
- muNet IP Interface

# Sensus Metering Systems

## iCON™ Residential Meter

### Product Availability

Service	Class	Form
2-wire	100	1S
3-wire	200, 300	2S
2-wire	20	3S
3-wire	20	4S
3-wire	200	12S
3-wire	200	25S

### Specifications

#### Power Requirements

- Voltage Rating: 2S 240V, 12S 120V
- Frequency: 60 Hz

#### Accuracy

- Exceeds Accuracy Class 0.2

#### Burden

- Power Supply < 0.8 watts/7.9VA @ 240VAC
- Voltage Circuit per phase: 0.03 watts @ 240VAC
- Current circuit per phase 0.1 milliohms Typical @ 25°C

#### LCD Display

- Six-digit liquid crystal display
- Data digit height: 0.4
- Simulated mechanical disk emulation / 1 watt-hour increments
- Power flow indicator
- kWh display with segment check option

#### Operating Environment

- Temperature: -40° to +85°C
- Humidity: 0% to 95% non-condensing
- Transient / Surge Suppression: EN61000-4-4:1995 & EN61000-4-5:1995, exceed voltage and current surge requirements per Category 4

#### Complies with Industry Standards

- ANSI C12.1 – 2001
- ANSI C12.10 – 1997
- ANSI C37.90.1 – 1989
- FCC Part 15

#### Characteristic Data

- Starting Watts: 5
- Temperature Rise Specifications: Meets ANSI C12.1 Section 4.7.2.9

#### Tamper Detection Options

- If the iCon meter is reversed in the socket, energy is added to the forward direction
- The iCon meter can place a tamper message in the display that can alternate with the kWh reading

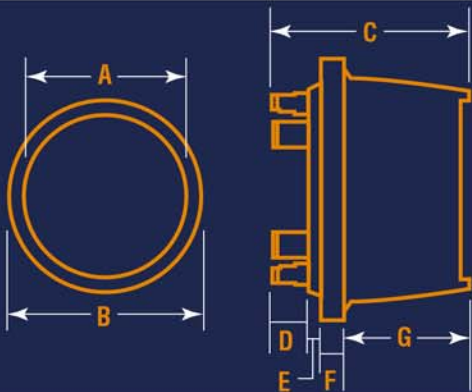

#### Dimensions

	A	B	C	D	E	F	G
in	6.42	6.95	5.00	0.91	0.32	0.56	1.42
cm	16.31	17.65	12.70	2.31	0.81	1.42	8.13

#### Shipping Weight

4 Meter Cartons	8 lbs	3.6 kg
96 Meter Pallet	228 lbs	103 kg



1501 Ardmore Blvd.  
6th Floor  
Pittsburgh, PA 15221  
800-638-3748  
Fax: 1-800-888-2403  
www.sensus.com  
(open "North America Electric")